



SEMITOP® 2

IGBT Module

SK60GAL125

SK60GAR125

Target Data

Features

- Compact design
- One screw mounting
- Heat transfer and isolation through direct copper bonded aluminium oxide ceramic (DCB)
- High short circuit capability
- Ultra Fast NPT IGBT technology
- $V_{ce,sat}$ with positive coefficient

Typical Applications*

- Switching (not for linear use)
- Inverter
- Switched mode power supplies
- UPS

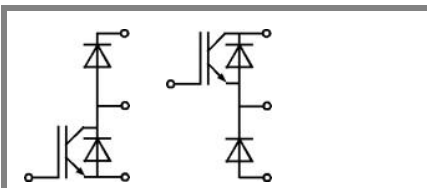

GAL

GAR

Absolute Maximum Ratings		$T_s = 25\text{ °C}$, unless otherwise specified		
Symbol	Conditions	Values		Units
IGBT				
V_{CES}	$T_j = 25\text{ °C}$	1200		V
I_C	$T_j = 125\text{ °C}$	$T_s = 25\text{ °C}$	51	A
		$T_s = 80\text{ °C}$	35	A
I_{CRM}	$I_{CRM} = 2 \times I_{Cnom}$	100		A
V_{GES}		± 20		V
t_{psc}	$V_{CC} = 300\text{ V}; V_{GE} \leq 20\text{ V}; T_j = 125\text{ °C}$ $V_{CES} < 600\text{ V}$	10		µs
Inverse Diode				
I_F	$T_j = 150\text{ °C}$	$T_s = 25\text{ °C}$	43	A
		$T_s = 80\text{ °C}$	29	A
I_{FRM}	$I_{FRM} = 2 \times I_{Fnom}$			A
I_{FSM}	$t_p = 10\text{ ms}; \text{half sine wave } T_j = 25\text{ °C}$	110		A
Freewheeling Diode				
I_F	$T_j = 150\text{ °C}$	$T_s = 25\text{ °C}$	57	A
		$T_s = 80\text{ °C}$	38	A
I_{FRM}				A
I_{FSM}	$t_p = 10\text{ ms}; \text{half sine wave } T_j = 150\text{ °C}$	550		A
Module				
$I_{t(RMS)}$				A
T_{vj}		-40 ... +150		°C
T_{stg}		-40 ... +125		°C
V_{isol}	AC, 1 min.	2500		V

Characteristics		$T_s = 25\text{ °C}$, unless otherwise specified			
Symbol	Conditions	min.	typ.	max.	Units
IGBT					
$V_{GE(th)}$	$V_{GE} = V_{CE}, I_C = 2\text{ mA}$	4,5	5,5	6,5	V
I_{CES}	$V_{GE} = 0\text{ V}, V_{CE} = V_{CES} T_j = 25\text{ °C}$			0,006	mA
I_{GES}	$V_{CE} = 0\text{ V}, V_{GE} = 20\text{ V} T_j = 25\text{ °C}$			300	nA
V_{CE0}		$T_j = 25\text{ °C}$	1,4	1,9	V
		$T_j = 125\text{ °C}$	1,7	2,2	V
r_{CE}	$V_{GE} = 15\text{ V}$	$T_j = 25\text{ °C}$	36		mΩ
		$T_j = 125\text{ °C}$	43		mΩ
$V_{CE(sat)}$	$I_{Cnom} = 50\text{ A}, V_{GE} = 15\text{ V}$	$T_j = 25\text{ °C}_{chiplev.}$	3,2	3,7	V
		$T_j = 125\text{ °C}_{chiplev.}$	3,85		V
C_{ies}	$V_{CE} = 25, V_{GE} = 0\text{ V} f = 1\text{ MHz}$	3,3		nF	
C_{oes}		0,5		nF	
C_{res}		0,22		nF	
$t_{d(on)}$	$R_{Gon} = 33\text{ } \Omega$	$V_{CC} = 600\text{ V}$ $I_C = 45\text{ A}$	8,36		ns
t_r					ns
E_{on}	$R_{Goff} = 33\text{ } \Omega$	$T_j = 125\text{ °C}$ $V_{GE} = \pm 15\text{ V}$	3,32		mJ
$t_{d(off)}$					ns
t_f					ns
E_{off}					mJ
$R_{th(j-s)}$	per IGBT			0,6	K/W



SEMITOP® 2

IGBT Module

SK60GAL125

SK60GAR125

Target Data

Features

- Compact design
- One screw mounting
- Heat transfer and isolation through direct copper bonded aluminium oxide ceramic (DCB)
- High short circuit capability
- Ultra Fast NPT IGBT technology
- $V_{ce,sat}$ with positive coefficient

Typical Applications*

- Switching (not for linear use)
- Inverter
- Switched mode power supplies
- UPS

Characteristics				min.	typ.	max.	Units
Symbol	Conditions						
Inverse Diode							
$V_F = V_{EC}$	$I_{Fnom} = 10 \text{ A}; V_{GE} = 0 \text{ V}$	$T_j = 25 \text{ }^\circ\text{C}_{chiplev.}$		2		2,5	V
		$T_j = 150 \text{ }^\circ\text{C}_{chiplev.}$		1,79		2,3	V
V_{F0}		$T_j = 25 \text{ }^\circ\text{C}$					V
		$T_j = 125 \text{ }^\circ\text{C}$			1,18		V
r_F		$T_j = 25 \text{ }^\circ\text{C}$					mΩ
		$T_j = 125 \text{ }^\circ\text{C}$			31,5		mΩ
I_{RRM}	$I_F = 30 \text{ A}$	$T_j = 125 \text{ }^\circ\text{C}$					A
Q_{rr}	$di/dt = -100 \text{ A}/\mu\text{s}$						μC
E_{rr}	$V_{CC} = 400\text{V}$						mJ
$R_{th(j-s)D}$	per diode					1,16	K/W
Freewheeling Diode							
$V_F = V_{EC}$	$I_{Fnom} = 50 \text{ A}; V_{GE} = 0 \text{ V}$	$T_j = 25 \text{ }^\circ\text{C}_{chiplev.}$		2		2,5	V
		$T_j = 125 \text{ }^\circ\text{C}_{chiplev.}$		1,8			V
V_{F0}		$T_j = 125 \text{ }^\circ\text{C}$				1,2	V
r_F		$T_j = 125 \text{ }^\circ\text{C}$			16	22	V
I_{RRM}	$I_F = 50 \text{ A}$	$T_j = 125 \text{ }^\circ\text{C}$					A
Q_{rr}	$di/dt = -800 \text{ A}/\mu\text{s}$						μC
E_{rr}	$V_R = 600\text{V}$						mJ
$R_{th(j-s)FD}$	per diode					0,9	K/W
M_s	to heat sink					2	Nm
w						19	g

This is an electrostatic discharge sensitive device (ESDS), international standard IEC 60747-1, Chapter IX.

* The specifications of our components may not be considered as an assurance of component characteristics. Components have to be tested for the respective application. Adjustments may be necessary. The use of SEMIKRON products in life support appliances and systems is subject to prior specification and written approval by SEMIKRON. We therefore strongly recommend prior consultation of our personal.

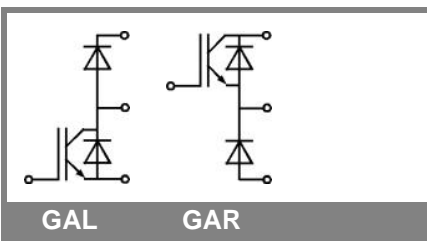

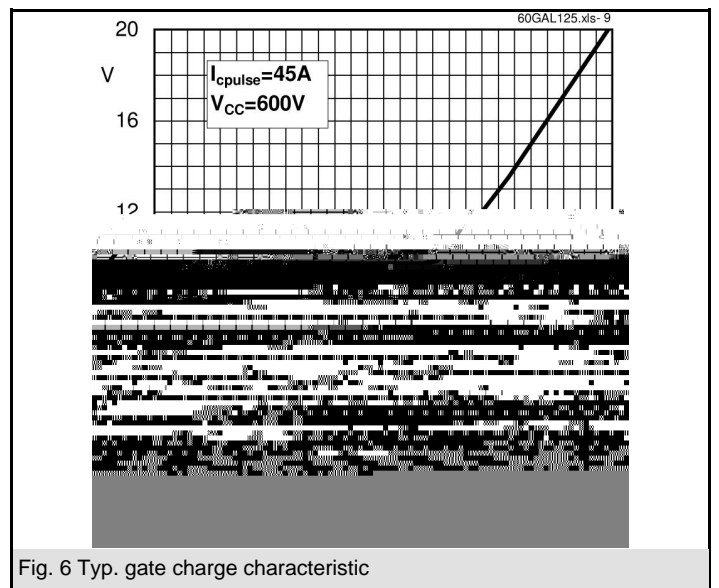
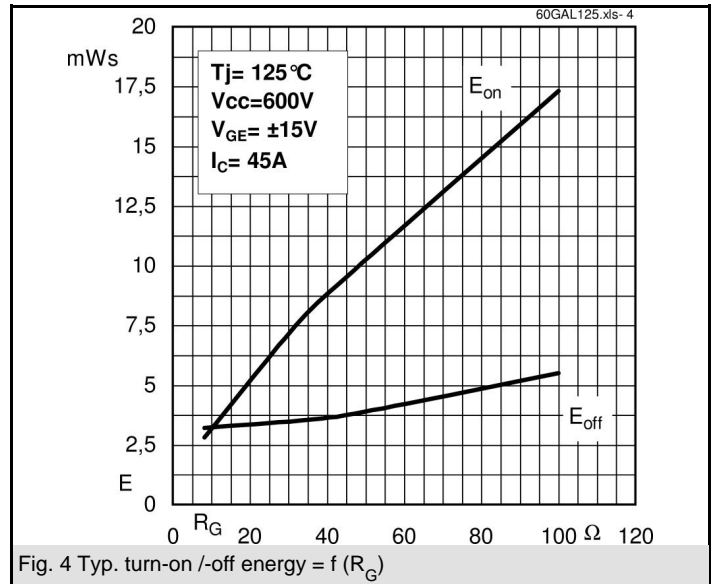
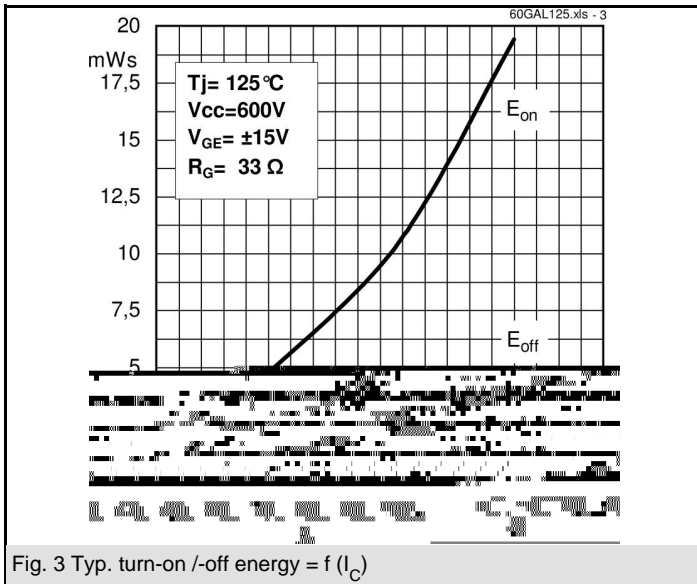
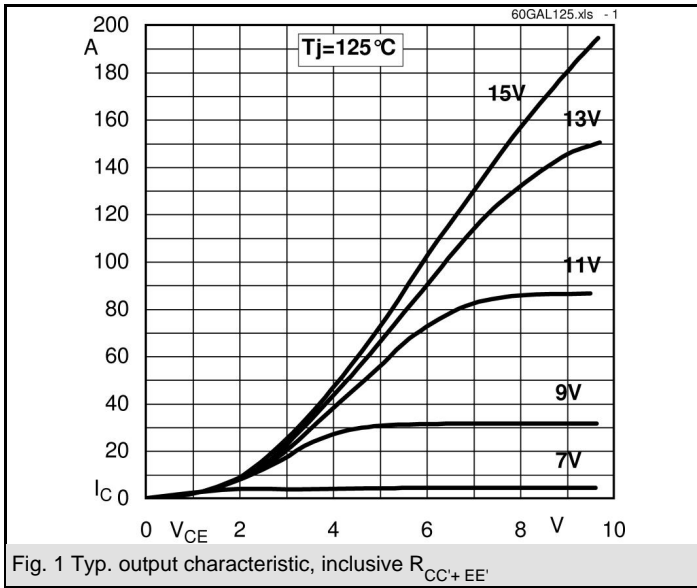

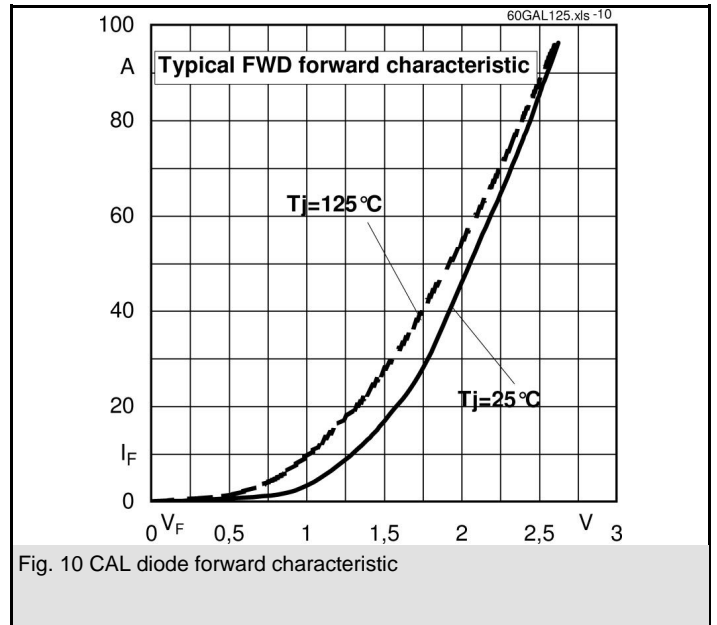
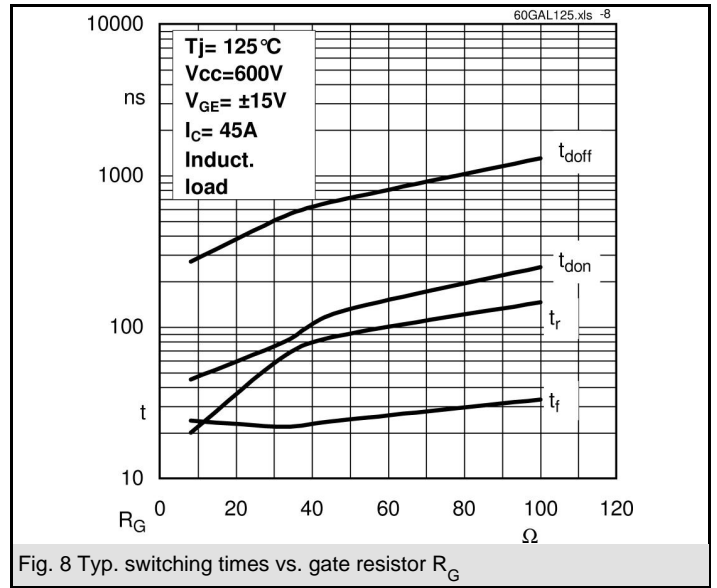
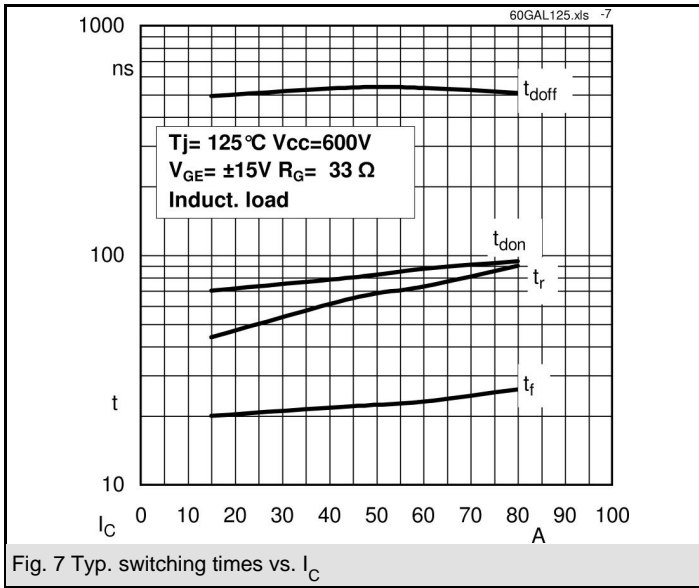

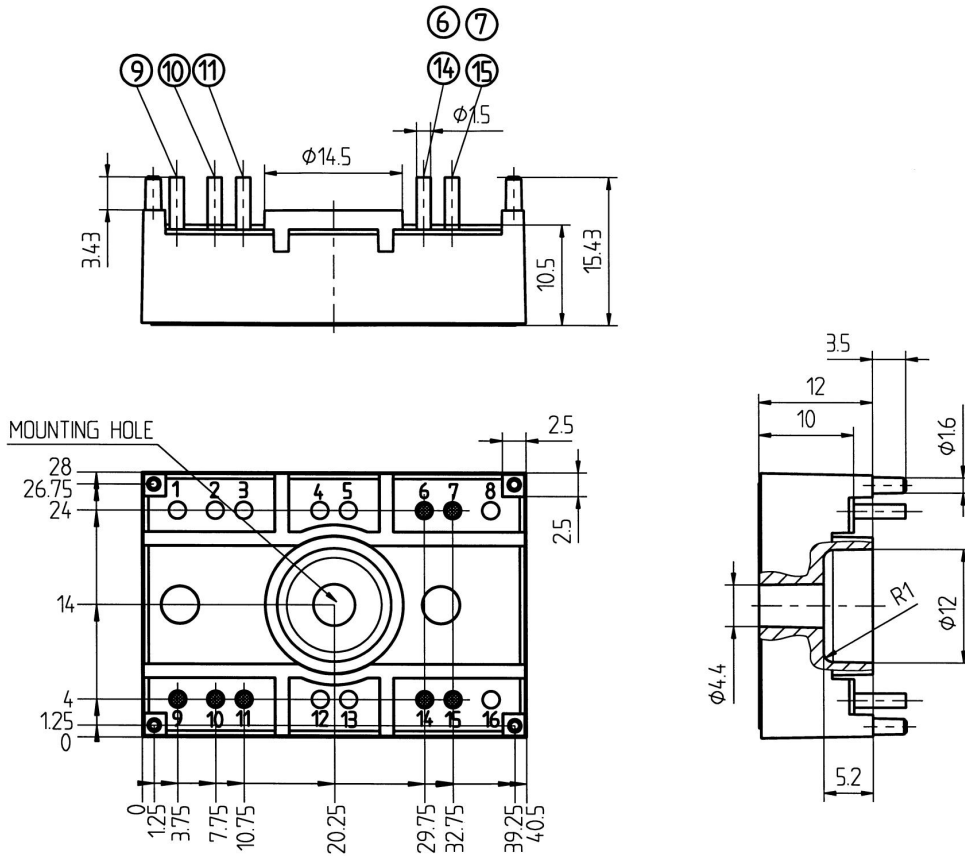

Case T18 (Suggested hole diameter, in the PCB, for solder pins and plastic mounting pins: 2mm)

