



SEMITOP[®] 2

IGBT Module

SK45GB063

SK45GAL063

SK45GAR063

Preliminary Data

Features

- Compact design
- One screw mounting
- Heat transfer and isolation through direct copper bonded aluminium oxide ceramic (DCB)
- N channel, homogeneous Silicon structure (NPT-Non punchthrough IGBT)
- High short circuit capability
- Low tail current with low temperature dependence
- UL recognized, file no. E63532

Typical Applications*

- Switching (not for linear use)
- Inverter
- Switched mode power supplies
- UPS

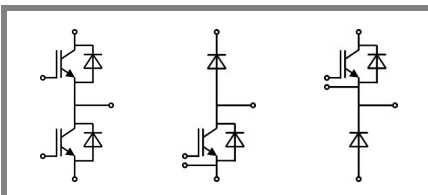

GB

GAL

GAR

Absolute Maximum Ratings		$T_s = 25\text{ °C}$, unless otherwise specified	
Symbol	Conditions	Values	Units
IGBT			
V_{CES}	$T_j = 25\text{ °C}$	600	V
I_C	$T_j = 125\text{ °C}$	$T_s = 25\text{ °C}$	45 A
		$T_s = 80\text{ °C}$	30 A
I_{CRM}	$I_{CRM} = 2 \times I_{Cnom}$	100	A
V_{GES}		± 20	V
t_{psc}	$V_{CC} = 300\text{ V}; V_{GE} \leq 20\text{ V}; T_j = 125\text{ °C}$ $V_{CES} < 600\text{ V}$	10	μs

Inverse Diode		$T_s = 25\text{ °C}$, unless otherwise specified	
Symbol	Conditions	Values	Units
I_F	$T_j = 150\text{ °C}$	$T_s = 25\text{ °C}$	57 A
		$T_s = 80\text{ °C}$	38 A
I_{FRM}			A
I_{FSM}	$t_p = 10\text{ ms}$; half sine wave $T_j = 150\text{ °C}$	440	A

Freewheeling Diode		$T_s = 25\text{ °C}$, unless otherwise specified	
Symbol	Conditions	Values	Units
I_F	$T_j = 150\text{ °C}$	$T_s = 25\text{ °C}$	57 A
		$T_s = 80\text{ °C}$	38 A
I_{FRM}			A
I_{FSM}	$t_p = 15\text{ ms}$; $T_j = \text{ °C}$	440	A

Module		$T_s = 25\text{ °C}$, unless otherwise specified	
Symbol	Conditions	Values	Units
$I_{t(RMS)}$			A
T_{vj}		-40 ... +150	$^{\circ}\text{C}$
T_{stg}		-40 ... +125	$^{\circ}\text{C}$
V_{isol}	AC, 1 min.	2500	V

Characteristics		$T_s = 25\text{ °C}$, unless otherwise specified			
Symbol	Conditions	min.	typ.	max.	Units
IGBT					
$V_{GE(th)}$	$V_{GE} = V_{CE}, I_C = 1\text{ mA}$	4,5	5,5	6,5	V
I_{CES}	$V_{GE} = 0\text{ V}, V_{CE} = V_{CES}$	$T_j = 25\text{ °C}$		0,15	mA
		$T_j = 125\text{ °C}$			mA
I_{GES}	$V_{CE} = 0\text{ V}, V_{GE} = 30\text{ V}$	$T_j = 25\text{ °C}$		120	nA
		$T_j = 125\text{ °C}$			nA
V_{CE0}		$T_j = 25\text{ °C}$	1		V
		$T_j = 125\text{ °C}$	1,1		V
r_{CE}	$V_{GE} = 15\text{ V}$	$T_j = 25\text{ °C}$	20		$\text{m}\Omega$
		$T_j = 125\text{ °C}$			$\text{m}\Omega$
$V_{CE(sat)}$	$I_{Cnom} = 50\text{ A}, V_{GE} = 15\text{ V}$	$T_j = 25\text{ °C}_{chiplev.}$	2,1	2,5	V
		$T_j = 125\text{ °C}_{chiplev.}$			V
C_{ies}	$V_{CE} = 25, V_{GE} = 0\text{ V}$		2,2		nF
C_{oes}		$f = 1\text{ MHz}$			nF
C_{res}			0,2		nF
Q_G	$V_{GE} = 0 \dots 20\text{ V}$		155		nC
$t_{d(on)}$	$R_{Gon} = 22\ \Omega$	$V_{CC} = 300\text{ V}$ $I_C = 30\text{ A}$		45	ns
			$T_j = 125\text{ °C}$	35	ns
t_r	$R_{Goff} = 22\ \Omega$	$T_j = 125\text{ °C}$ $V_{GE} = \pm 15\text{ V}$		1,4	mJ
			$T_j = 125\text{ °C}$	250	ns
E_{on}				25	ns
				1,2	mJ
$t_{d(off)}$					ns
t_f					ns
E_{off}					mJ
$R_{th(j-s)}$	per IGBT			1	K/W



SEMITOP[®] 2

IGBT Module

SK45GB063

SK45GAL063

SK45GAR063

Preliminary Data

Features

- Compact design
- One screw mounting
- Heat transfer and isolation through direct copper bonded aluminium oxide ceramic (DCB)
- N channel, homogeneous Silicon structure (NPT-Non punchthrough IGBT)
- High short circuit capability
- Low tail current with low temperature dependence
- UL recognized, file no. E63532

Typical Applications*

- Switching (not for linear use)
- Inverter
- Switched mode power supplies
- UPS

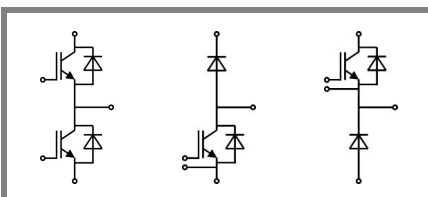

GB

GAL

GAR

Characteristics				min.	typ.	max.	Units
Symbol	Conditions						
Inverse Diode							
$V_F = V_{EC}$	$I_{Fnom} = 30 \text{ A}; V_{GE} = 0 \text{ V}$	$T_j = 25 \text{ }^\circ\text{C}_{\text{chiplev.}}$		1,45	1,7		V
		$T_j = 125 \text{ }^\circ\text{C}_{\text{chiplev.}}$		1,4	1,75		V
V_{F0}		$T_j = 125 \text{ }^\circ\text{C}$		0,85	0,9		V
r_F		$T_j = 125 \text{ }^\circ\text{C}$		9	16		mΩ
I_{RRM}	$I_F = 30 \text{ A}$	$T_j = 125 \text{ }^\circ\text{C}$		16			A
Q_{rr}	$di/dt = -500 \text{ A}/\mu\text{s}$			2			μC
E_{rr}	$V_{CC} = 300 \text{ V}$			0,25			mJ
$R_{th(j-s)D}$	per diode					1,2	K/W
Freewheeling Diode							
$V_F = V_{EC}$	$I_{Fnom} = 30 \text{ A}; V_{GE} = 0 \text{ V}$	$T_j = 25 \text{ }^\circ\text{C}_{\text{chiplev.}}$		1,45	1,7		V
		$T_j = 125 \text{ }^\circ\text{C}_{\text{chiplev.}}$		1,4	1,75		V
V_{F0}		$T_j = 125 \text{ }^\circ\text{C}$		0,85	0,9		V
r_F		$T_j = 125 \text{ }^\circ\text{C}$		9	16		V
I_{RRM}	$I_F = 30 \text{ A}$	$T_j = 125 \text{ }^\circ\text{C}$		16			A
Q_{rr}	$di/dt = -500 \text{ A}/\mu\text{s}$			2			μC
E_{rr}	$V_{CC} = 300 \text{ V}$			0,25			mJ
$R_{th(j-s)FD}$	per diode					1,2	K/W
M_s	to heat sink					2	Nm
w						19	g

This is an electrostatic discharge sensitive device (ESDS), international standard IEC 60747-1, Chapter IX.

* The specifications of our components may not be considered as an assurance of component characteristics. Components have to be tested for the respective application. Adjustments may be necessary. The use of SEMIKRON products in life support appliances and systems is subject to prior specification and written approval by SEMIKRON. We therefore strongly recommend prior consultation of our personal.

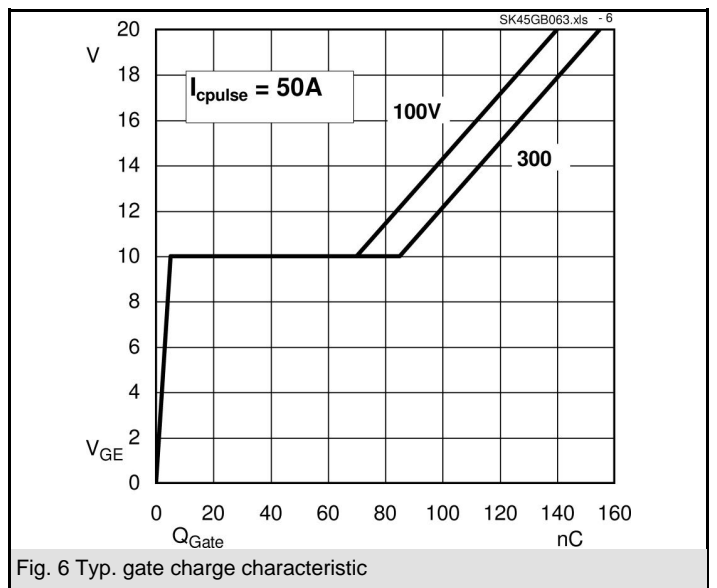
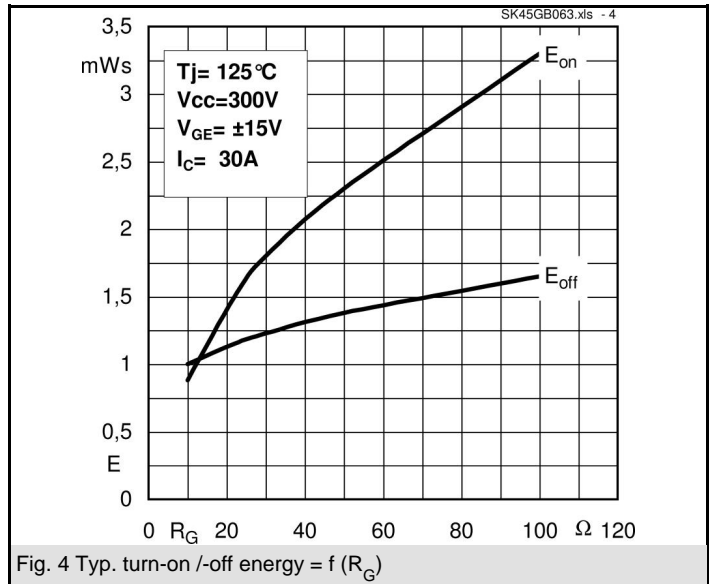
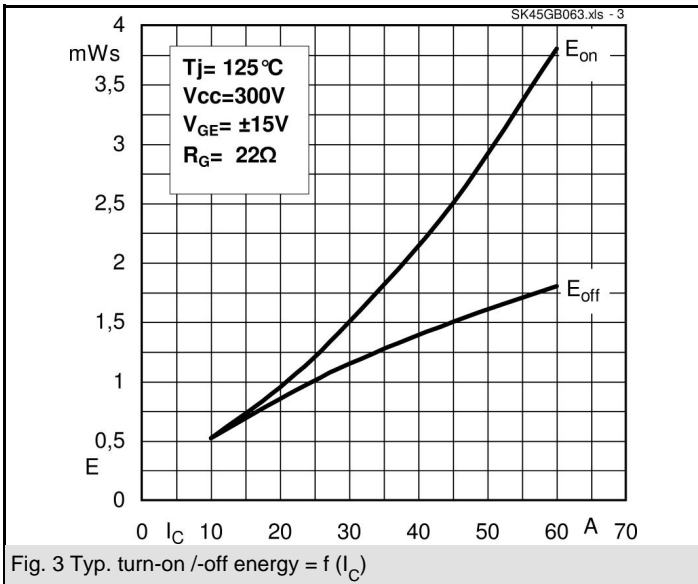
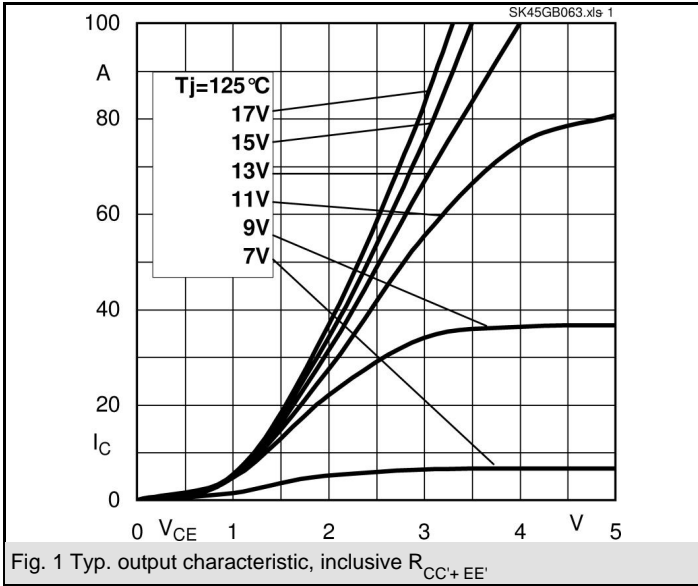

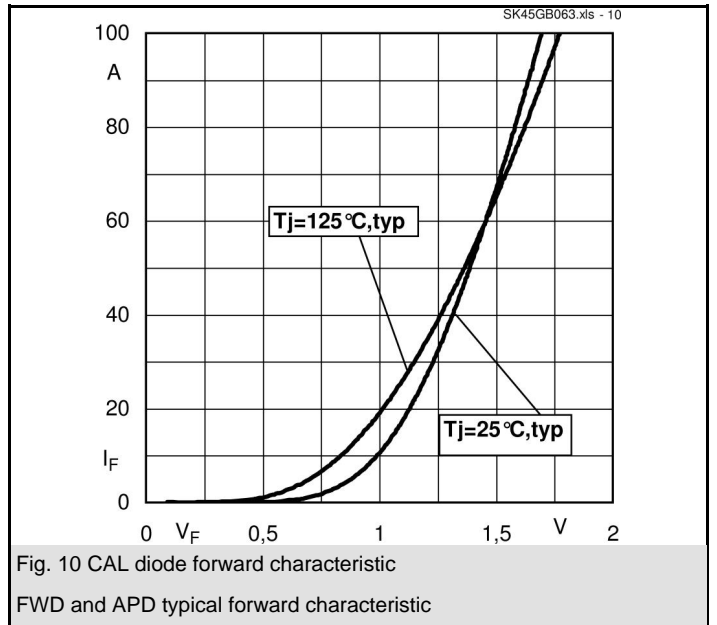
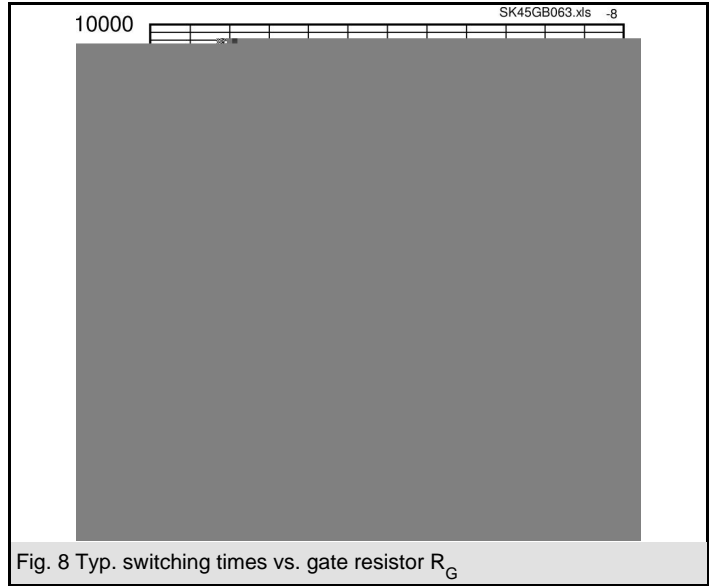
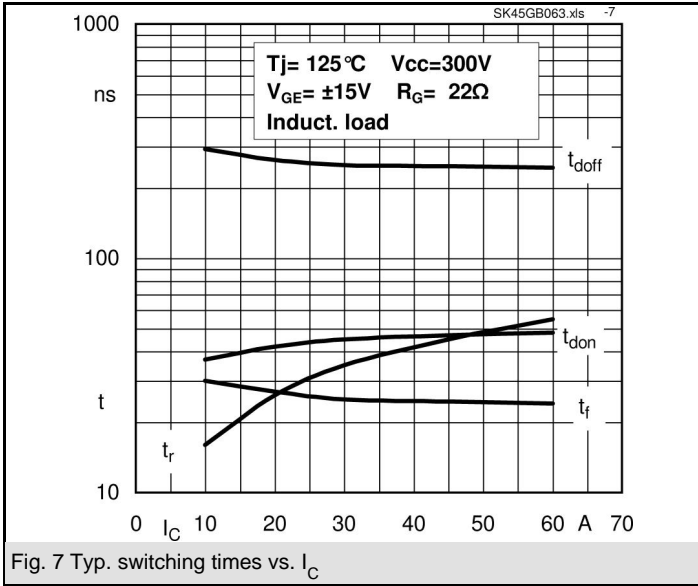

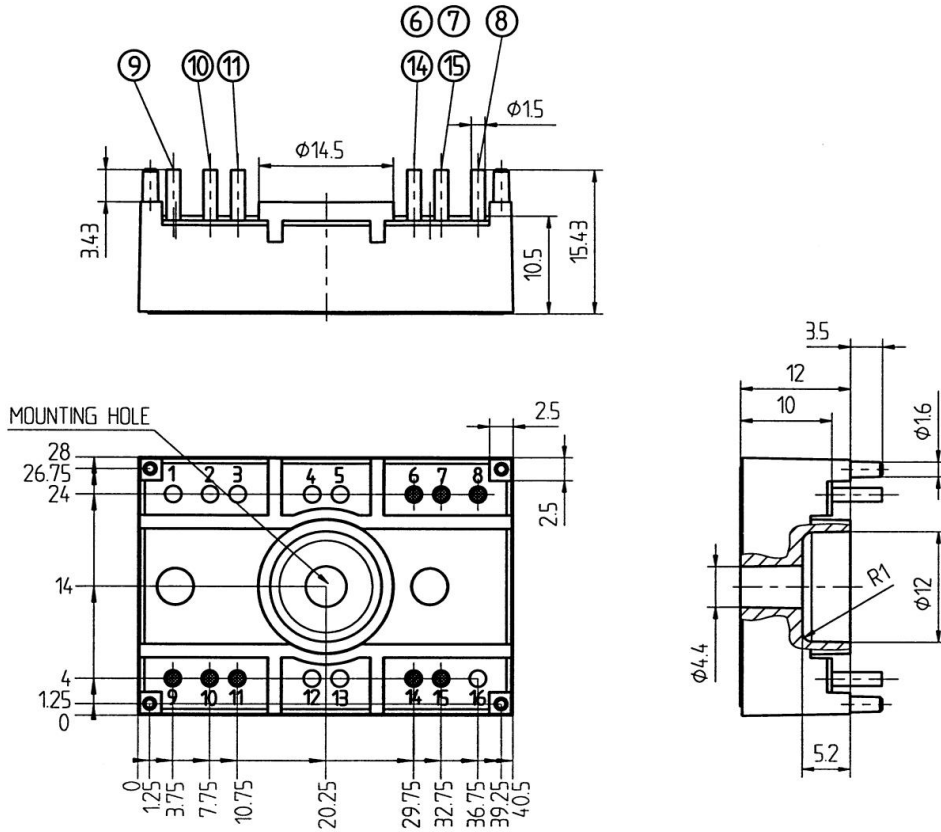

Case T4 (Suggested hole diameter, in the PCB, for solder pins and plastic mounting pins: 2mm)

