



SEMITOP[®] 2

IGBT Module

SK25GH063

Preliminary Data

Features

- Compact design
- One screw mounting
- Heat transfer and isolation through direct copper bonded aluminium oxide ceramic (DCB)
- N channel, homogeneous Silicon structure (NPT-Non punchthrough IGBT)
- High short circuit capability
- Low tail current with low temperature dependence
- UL recognized, file no. E63532

Typical Applications*

- Switching (not for linear use)
- Inverter
- Switched mode power supplies
- UPS

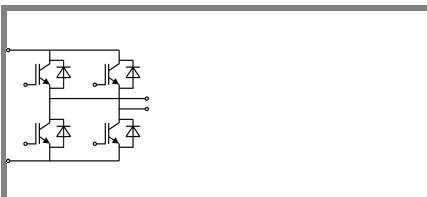

GH

Absolute Maximum Ratings		$T_s = 25\text{ °C}$, unless otherwise specified			
Symbol	Conditions	Values			Units
IGBT					
V_{CES}	$T_j = 25\text{ °C}$	600			V
I_C	$T_j = 125\text{ °C}$	$T_s = 25\text{ °C}$	30		A
		$T_s = 80\text{ °C}$	21		A
I_{CRM}	$I_{CRM} = 2 \times I_{Cnom}$	60			A
V_{GES}		± 20			V
t_{psc}	$V_{CC} = 300\text{ V}; V_{GE} \leq 20\text{ V}; T_j = 125\text{ °C}$ $V_{CES} < 600\text{ V}$	10			μs
Inverse Diode					
I_F	$T_j = 150\text{ °C}$	$T_s = 25\text{ °C}$	36		A
		$T_s = 80\text{ °C}$	24		A
I_{FRM}	$I_{FRM} = 2 \times I_{Fnom}$				A
I_{FSM}	$t_p = 10\text{ ms}; \text{half sine wave } T_j = 150\text{ °C}$	200			A
Module					
$I_{t(RMS)}$					A
T_{vj}		-40 ... +150			$^{\circ}\text{C}$
T_{stg}		-40 ... +125			$^{\circ}\text{C}$
V_{isol}	AC, 1 min.	2500			V

Characteristics		$T_s = 25\text{ °C}$, unless otherwise specified				
Symbol	Conditions	min.	typ.	max.	Units	
IGBT						
$V_{GE(th)}$	$V_{GE} = V_{CE}, I_C = 0,7\text{ mA}$	4,5	5,5	6,5	V	
I_{CES}	$V_{GE} = 0\text{ V}, V_{CE} = V_{CES}$	$T_j = 25\text{ °C}$			0,1	mA
		$T_j = 125\text{ °C}$				mA
I_{GES}	$V_{CE} = 0\text{ V}, V_{GE} = 30\text{ V}$	$T_j = 25\text{ °C}$			120	nA
		$T_j = 125\text{ °C}$				nA
V_{CE0}		$T_j = 25\text{ °C}$	1		V	
		$T_j = 125\text{ °C}$	1,1		V	
r_{CE}	$V_{GE} = 15\text{ V}$	$T_j = 25\text{ °C}$	37		m Ω	
		$T_j = 125\text{ °C}$	30		m Ω	
$V_{CE(sat)}$	$I_{Cnom} = 30\text{ A}, V_{GE} = 15\text{ V}$	$T_j = 25\text{ °C}_{chiplev.}$	2,1	2,5	V	
		$T_j = 125\text{ °C}_{chiplev.}$	2	2,3	V	
C_{ies}	$V_{CE} = 25, V_{GE} = 0\text{ V}$	$f = 1\text{ MHz}$	1,3		nF	
C_{oes}			0,15		nF	
C_{res}			0,1		nF	
$t_{d(on)}$	$R_{Gon} = 33\ \Omega$	$V_{CC} = 300\text{ V}$ $I_C = 25\text{ A}$	37		ns	
t_r			40		ns	
E_{on}	$R_{Goff} = 33\ \Omega$	$T_j = 125\text{ °C}$ $V_{GE} = \pm 15\text{ V}$	1,1		mJ	
$t_{d(off)}$			200		ns	
t_f			30		ns	
E_{off}			0,8		mJ	
$R_{th(j-s)}$	per IGBT	1,4			K/W	



SEMITOP[®] 2

IGBT Module

SK25GH063

Preliminary Data

Features

- Compact design
- One screw mounting
- Heat transfer and isolation through direct copper bonded aluminium oxide ceramic (DCB)
- N channel, homogeneous Silicon structure (NPT-Non punchthrough IGBT)
- High short circuit capability
- Low tail current with low temperature dependence
- UL recognized, file no. E63532

Typical Applications*

- Switching (not for linear use)
- Inverter
- Switched mode power supplies
- UPS

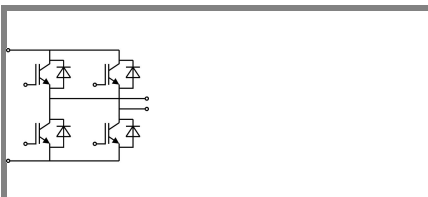

GH

Characteristics

Symbol	Conditions	min.	typ.	max.	Units
Inverse Diode					
$V_F = V_{EC}$	$I_{Fnom} = 25 \text{ A}; V_{GE} = 0 \text{ V}$				
	$T_j = 25 \text{ }^\circ\text{C}_{\text{chiplev.}}$		1,45	1,7	V
	$T_j = 125 \text{ }^\circ\text{C}_{\text{chiplev.}}$		1,4	1,75	V
V_{F0}					
	$T_j = 125 \text{ }^\circ\text{C}$		0,85	0,9	V
r_F					
	$T_j = 125 \text{ }^\circ\text{C}$		22	32	mΩ
I_{RRM}	$I_F = 25 \text{ A}$				
Q_{rr}	$di/dt = -500 \text{ A}/\mu\text{s}$				
	$T_j = 125 \text{ }^\circ\text{C}$		16		A
E_{rr}	$V_{CC} = 300 \text{ V}$				
			2		μC
			0,25		mJ
$R_{th(j-s)D}$	per diode				
				1,7	K/W
M_s	to heat sink M1				
				2	Nm
w					
			21		g

This is an electrostatic discharge sensitive device (ESDS), international standard IEC 60747-1, Chapter IX.

* The specifications of our components may not be considered as an assurance of component characteristics. Components have to be tested for the respective application. Adjustments may be necessary. The use of SEMIKRON products in life support appliances and systems is subject to prior specification and written approval by SEMIKRON. We therefore strongly recommend prior consultation of our personal.

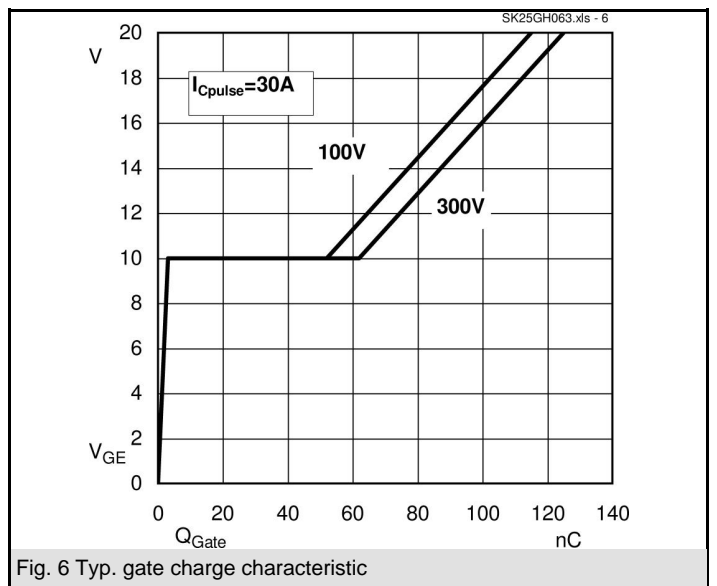
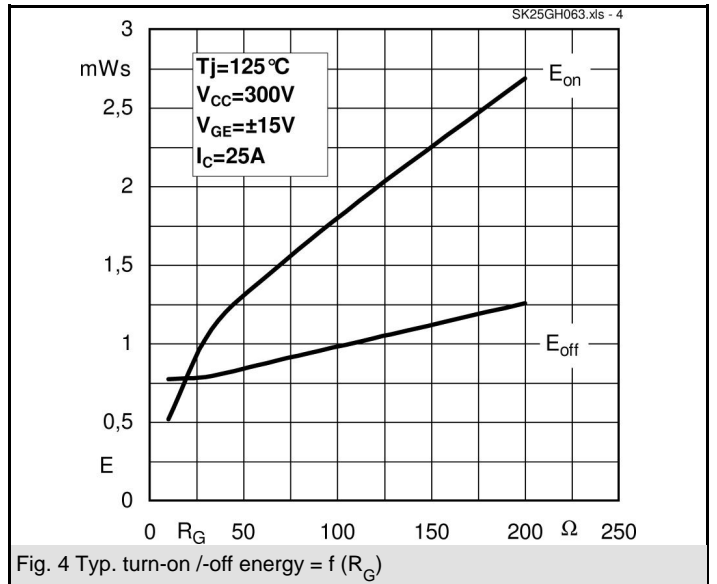
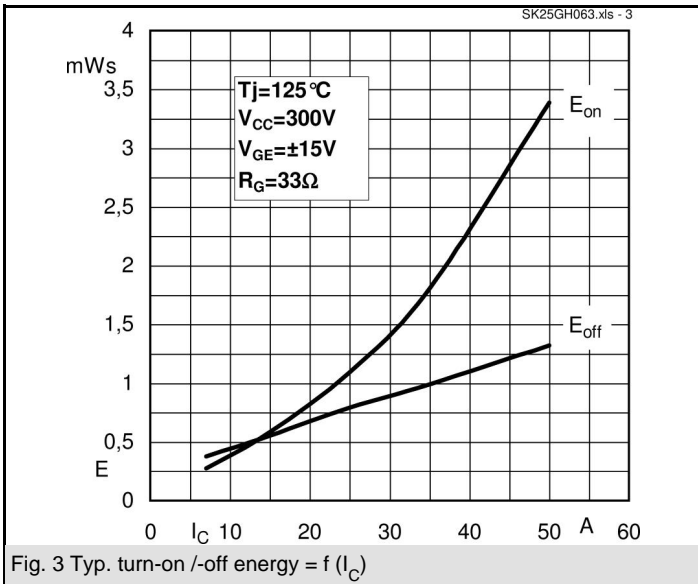
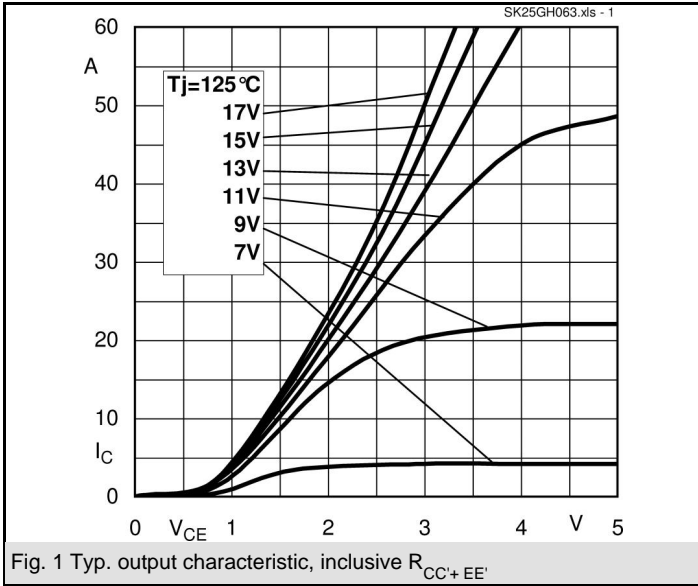

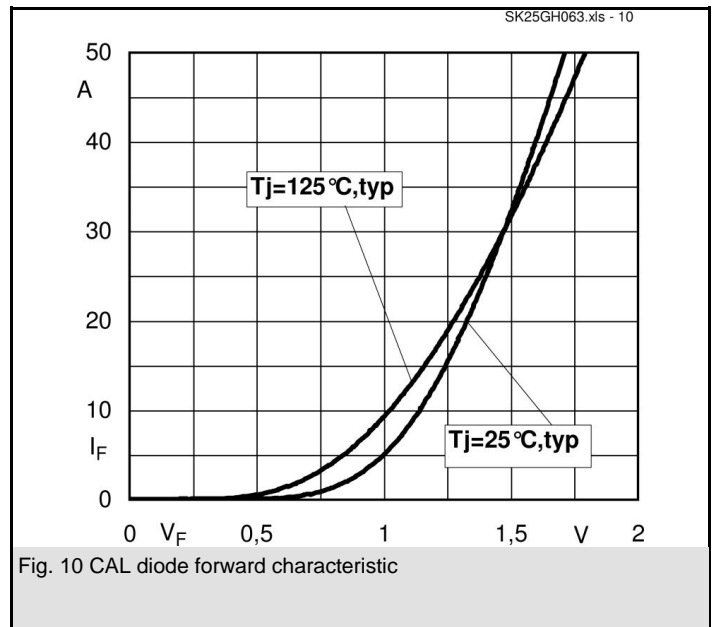
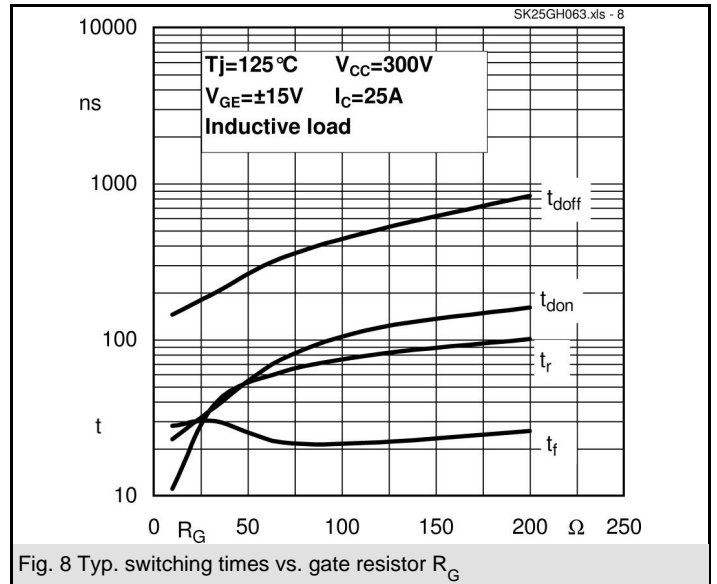
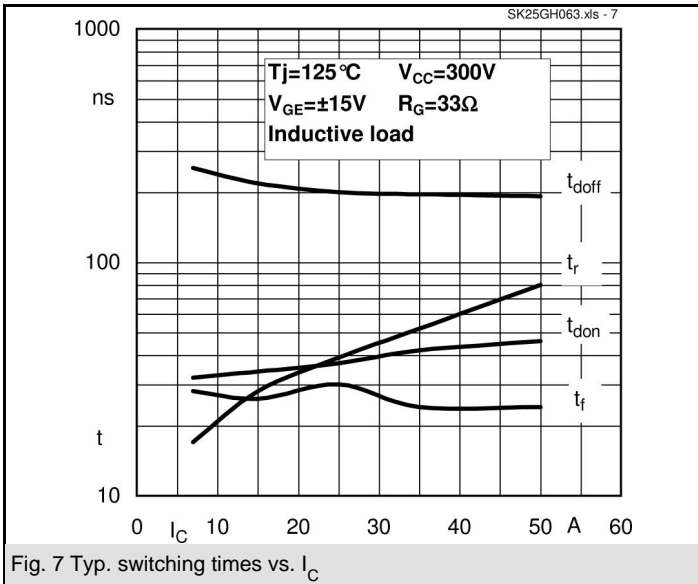

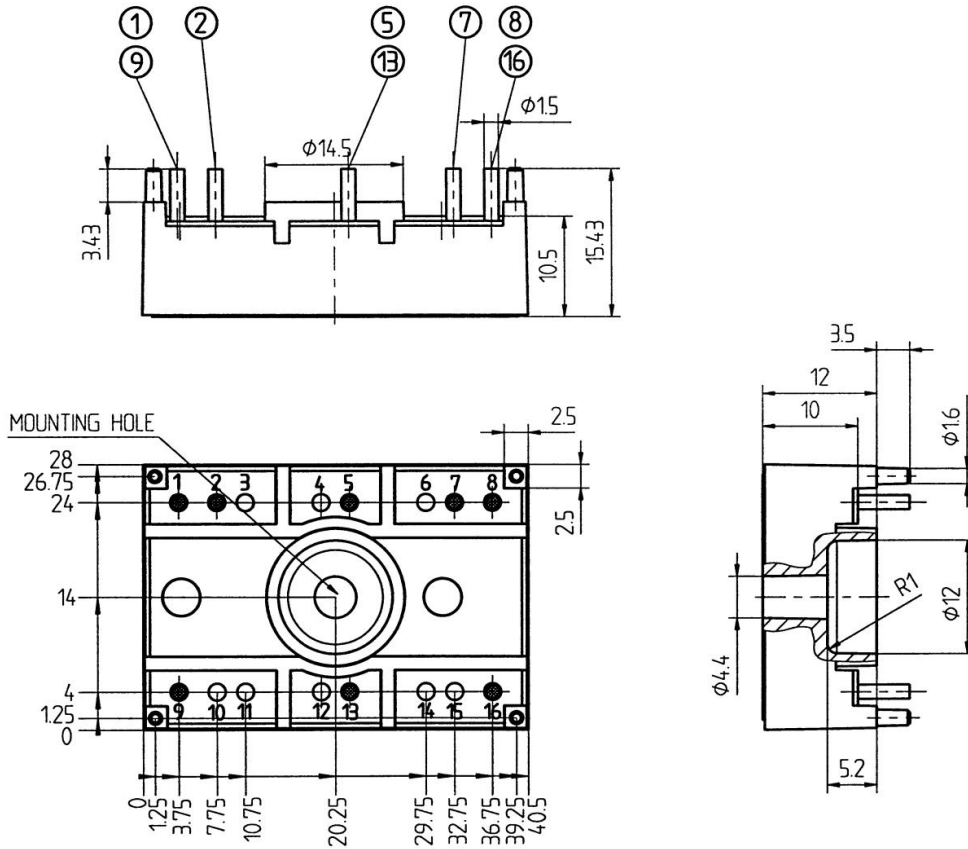

Case T5 (Suggested hole diameter, in the PCB, for solder pins and plastic mounting pins:2mm)

